

PROJECT
TYPE
CATALOG #

# 20-FHBSR

SENSOR READY FULL-BODY HIGH BAY LUMEN & KELVIN SELECTABLE

## HOUSING

- Premium powder-coat, die cast aluminum, white housing.

## ELECTRICAL

- Operating temperature (ambient):  
-40°C to 55°C (-40°F to 131°F) for FHBSR-181512L and FHBSR241815L.  
-40°C to 50°C (-40°F to 122°F) for FHBSR-363024L and FHBSR604836L.
- Universal 120-277V AC voltage (50-60Hz) is standard.
- 347-480V achieved with step-down transformer.
- 0-10vdc dimming drivers are standard.
- Emergency driver option available.
- Input transient surge protection = 6kV.
- PF > 0.9 ; THD < 20%.

## OPTICAL SYSTEM

- Polycarbonate prismatic lens.
- Field selectable 4000k (neutral white) and 5000k (cool white) color temperatures\*.
- Tri-lumen selectable delivers 12,000 to 60,000 nominal lumens (see lumen tables on page 3-4)\*\*.
- Screw in sensor ready. Sensor and remote control sold separately.
- Remote control required to change factory sensor settings (see default settings on page 2).
- Long-life LEDs provide 135,000 hours of operation with at least 70% of initial lumen output (L70), and 41,000 hours with at least 90% of initial lumen output (L90)\*\*\*.
- LED color maintenance < 0.003 chromaticity shift ( $\Delta u'v'$ ) over the initial 6,000 hours of operation.
- Color rendering index > 80%.

## MOUNTING

- Chain-mount kits (includes v-hooks , 1-meter long chain) are standard.
- Optional surface mounting kit provides attachment to solid surfaces\*\*\*\*.
- Optional pendant mounting kit provides pendant attachment to 1/2" rigid conduit\*\*\*\*.
- Optional cable mount kit provides luminaire suspension.

## CODE COMPLIANCE

- cULus listed for damp locations.
- Complies with FCC part 15, class A.

## WARRANTY

- 5-year warranty on all electronics and housing.

\* Default kelvin temperature = 4000k.  
\*\* Default power setting = highest lumen output.  
\*\*\*L70 & L90 hours are IES TM-21-11 calculated hours.  
\*\*\*\* Surface and pendant mount kits are not compatible with either UNC or EM options.

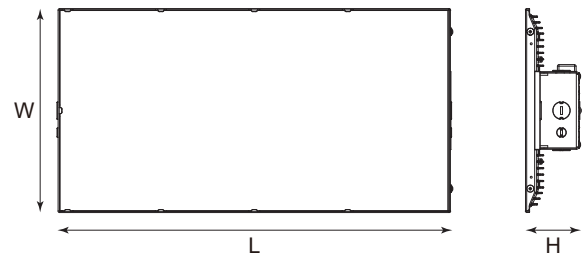

Model	Size (inches) & Weight (lbs)			
	L (in)	W (in)	H (in)	Weight
20-FHBSR-181512L-4K5K	13.00	9.50	2.20	3.7
20-FHBSR-241815L-4K5K	14.20	10.25	2.40	4.5
20-FHBSR-363024L-4K5K	19.70	10.25	2.60	6.5
20-FHBSR-604836L-4K5K	30.70	11.00	2.60	9.25



## PRODUCT PARAMETERS

SERIES	NOMINAL LUMEN OUTPUT (Selectable)	KELVIN (Selectable)	INPUT VOLTAGE	EMERGENCY DRIVER
20-FHBSR	181512L = 18,000lm / 15,000lm / 12,000lm 241815L = 24,000lm / 18,000lm / 15,000lm 363024L = 36,000lm / 30,000lm / 24,000lm 604836L = 60,000lm / 48,000lm / 36,000lm	4K5K	UNC* 347-480V Blank 120-277V	EM10 = 10W Emergency Driver EM13 = 10W Emergency Driver EM25 = 25W Emergency Driver Blank = No Emergency Driver

\* UNC option no compatible with EM



PROJECT
TYPE
CATALOG #

# 20-FHBSR

SENSOR READY FULL-BODY HIGH BAY LUMEN & KELVIN SELECTABLE

## ACCESSORIES (order separately)

### Sensor

- 20-HD07VR-PH-1-90 = Passive infrared sensor with 90° elbow adapter- maximum mounting height = 39FT,  
= factory settings: detection area =100%, hold time = 5 sec, stand-by period = 0 sec,  
stand-by dimming level = 10%, daylight threshold = disabled
- 20-HD07VR-MH-B-1-90 = Microwave step-dimming sensor with 90° elbow adapter - maximum mounting height = 49FT,  
= factory settings: detection area =100%, hold time = 5 sec, stand-by period = 0 sec, stand-by  
dimming level = 10%, daylight threshold = disabled
- 20-HD05R = Remote control for 20-HD07VR-PH-1-90 & 20-HD07VR-MH-B-1-90 (required to change factory settings)

### Wire Guard

- 20-FHBSR-WG-181512L = WIRE GUARD FOR 20-FHBSR-WG-181512L
- 20-FHBSR-WG-241815L = WIRE GUARD FOR 20-FHBSR-WG-241815L
- 20-FHBSR-WG-363024L = WIRE GUARD FOR 20-FHBSR-WG-363024L
- 20-FHBSR-WG-604836L = WIRE GUARD FOR 20-FHBSR-WG-604836L

### Mounting Option

- 20-FHBSR-SMK = SURFACE MOUNT KIT FOR 20-FHBSR- ALL MODELS\*
- 20-FHBSR-PMK = PENDANT MOUNT KIT FOR 20-FHBSR- ALL MODELS\*
- 20-CMK-3 = CABLE MOUNT KIT 3 METER- ALL MODELS
- 20-CMK-5 = CABLE MOUNT KIT 5 METER- ALL MODELS

\* SMK and PMK are not compatible with UNC and EM drivers.

### Remote Mount EM Drivers

- 20-BLEM-CP-10C = EMERGENCY DRIVER - EM10
- 20-BLEM-CP-13C = EMERGENCY DRIVER - EM13

## COMPATIBLE EMERGENCY DRIVERS - INSTALLED

Emergency Driver Part Number	EM10		EM13		EM25	
	Watts	EM Lumens	Watts	EM Lumens	Watts	EM Lumens
20-FHBSR-181512L-4K5K	10	1400	13	1820	25	3500
20-FHBSR-241815L-4K5K	10	1500	13	1950	25	3750
20-FHBSR-363024L-4K5K	10	1400	13	1820	25	3500
20-FHBSR-604836L-4K5K	10	1500	13	1950	25	3750

## COMPATIBLE DIMMERS & CONTROLS

Manufacturer	Model Number	Dimmer Range	Load Switching Capacity
Leviton	IP710-LFZ	10%-100%	1200W
Lutron	DVSTV	10%-100%	450W



PROJECT
TYPE
CATALOG #

# 20-FHBSR

SENSOR READY FULL-BODY HIGH BAY LUMEN & KELVIN SELECTABLE

## ELECTRICAL DATA

Series	Measurements	Low Lumens		Mid Lumens		High Lumens	
		4000k	5000k	4000k	5000k	4000k	5000k
20-FHBSR-181512L-4K5K	Lumens	12,454	12,245	15,387	14,987	18,260	17,662
	Watt	81.57	82.68	103.79	105.72	127.33	130.36
	Efficacy	153	148	148	142	143	135
	Input Current (A)	120V = 0.68	120V = 0.69	120V = 0.86	120V = 0.88	120V = 1.06	120V = 1.09
		240V = 0.34	240V = 0.34	240V = 0.43	240V = 0.44	240V = 0.53	240V = 0.54
		277V = 0.29	277V = 0.30	277V = 0.37	277V = 0.38	277V = 0.46	277V = 0.47

Series	Measurements	Low Lumens		Mid Lumens		High Lumens	
		4000k	5000k	4000k	5000k	4000k	5000k
20-FHBSR-241815L-4K5K	Lumens	15,480	15,446	18,164	17,944	23,772	23,381
	Watt	97.5	98.69	116.37	117.96	158.16	161.41
	Efficacy	159	157	156	152	150	145
	Input Current (A)	120V = 0.81	120V = 0.82	120V = 0.97	120V = 0.98	120V = 1.32	120V = 1.35
		240V = 0.41	240V = 0.41	240V = 0.48	240V = 0.49	240V = 0.66	240V = 0.67
		277V = 0.35	277V = 0.36	277V = 0.42	277V = 0.43	277V = 0.57	277V = 0.58



PROJECT
TYPE
CATALOG #

# 20-FHBSR

SENSOR READY FULL-BODY HIGH BAY LUMEN & KELVIN SELECTABLE

## ELECTRICAL DATA

Series	Measurements	Low Lumens		Mid Lumens		High Lumens	
		4000k	5000k	4000k	5000k	4000k	5000k
20-FHBSR-363024L-4K5K	Lumens	24,204	24,004	29,825	29,339	35,415	34,727
	Watt	151.23	154.24	192.09	196.72	235.36	242.2
	Efficacy	160	156	155	149	150	143
	Input Current (A)	120V = 1.26	120V = 1.29	120V = 1.60	120V = 1.64	120V = 1.96	120V = 2.02
		240V = 0.63	240V = 0.64	240V = 0.80	240V = 0.82	240V = 0.98	240V = 1.01
277V = 0.55		277V = 0.56	277V = 0.69	277V = 0.71	277V = 0.85	277V = 0.87	

Series	Measurements	Low Lumens		Mid Lumens		High Lumens	
		4000k	5000k	4000k	5000k	4000k	5000k
20-FHBSR-604836L-4K5K	Lumens	36,167	36,380	47,698	47,582	59,177	58,715
	Watt	224.7	228	305.1	309.5	389.6	397.7
	Efficacy	161	160	156	154	152	148
	Input Current (A)	120V = 1.87	120V = 1.90	120V = 2.54	120V = 2.58	120V = 3.25	120V = 3.31
		240V = 0.94	240V = 0.95	240V = 1.27	240V = 1.29	240V = 1.62	240V = 1.66
277V = 0.81		277V = 0.82	277V = 1.10	277V = 1.12	277V = 1.41	277V = 1.44	

PROJECT
TYPE
CATALOG #

# 20-FHBSR

SENSOR READY FULL-BODY HIGH BAY LUMEN & KELVIN SELECTABLE

## PHOTOMETRIC DATA

### 20-FHBSR-181512L-4K5K

#### Luminaire Data

Description	Full Body High Bay Lumen/Kelvin Selectable
Total Lumens	17,662
Input Wattage	130
Efficacy (lm/W)	135
Spacing Criterion (0-180°)	1.26
Spacing Criterion (90-270°)	1.24

Photometrics calculated at 5000k-high lumens setting

#### Zonal Lumen Summary

Zone	Lumens	%Fixt
0-20°	3,042	17.2%
0-30°	6,475	36.7%
0-40°	10,520	59.6%
20-50°	10,813	61.2%
40-70°	6,271	35.5%
0-60°	15,726	89.0%
0-80°	17,425	98.7%
0-90°	17,638	99.9%
90-180°	24	0.1%
0-180°	17,662	100.0%

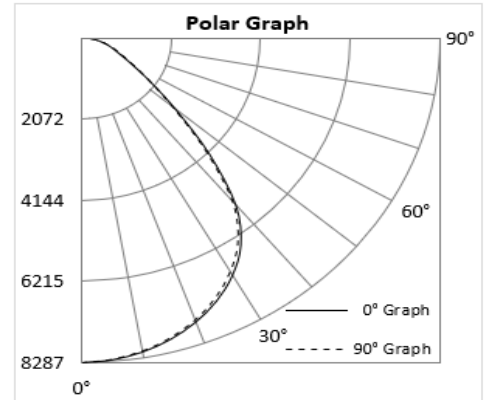

### 20-FHBSR-241815L-4K5K

#### Luminaire Data

Description	Full Body High Bay Lumen/Kelvin Selectable
Total Lumens	23,381
Input Wattage	161
Efficacy (lm/W)	145
Spacing Criterion (0-180°)	1.26
Spacing Criterion (90-270°)	1.28

Photometrics calculated at 5000k-high lumens setting

#### Zonal Lumen Summary

Zone	Lumens	%Fixt
0-20°	4,016	17.2%
0-30°	8,550	36.6%
0-40°	13,901	59.5%
20-50°	14,322	61.3%
40-70°	8,341	35.7%
0-60°	20,833	89.1%
0-80°	23,074	98.7%
0-90°	23,350	99.9%
90-180°	31	0.1%
0-180°	23,381	100.0%

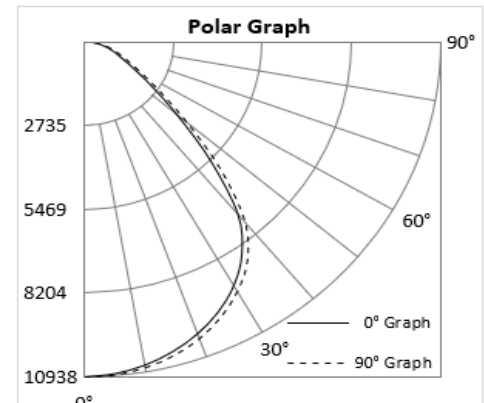

### 20-FHBSR-363024L-4K5K

#### Luminaire Data

Description	Full Body High Bay Lumen/Kelvin Selectable
Total Lumens	34,727
Input Wattage	242
Efficacy (lm/W)	143
Spacing Criterion (0-180°)	1.26
Spacing Criterion (90-270°)	1.28

Photometrics calculated at 5000k-high lumens setting

#### Zonal Lumen Summary

Zone	Lumens	%Fixt
0-20°	5,902	17.0%
0-30°	12,592	36.3%
0-40°	20,536	59.1%
20-50°	21,267	61.2%
40-70°	12,472	35.9%
0-60°	30,906	89.0%
0-80°	34,256	98.6%
0-90°	34,682	99.9%
90-180°	45	0.1%
0-180°	34,727	100.0%

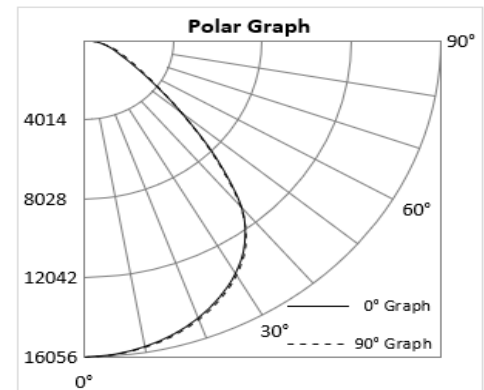

PROJECT
TYPE
CATALOG #

# 20-FHBSR

SENSOR READY FULL-BODY HIGH BAY LUMEN & KELVIN SELECTABLE

## 20-FHBSR604836L-4K5K

### Luminaire Data

Description	Full Body High Bay Lumen/Kelvin Selectable
Total Lumens	58,715
Input Wattage	398
Efficacy (lm/W)	148
Spacing Criterion (0-180°)	1.28
Spacing Criterion (90-270°)	1.26

Photometrics calculated at 5000k-high lumens setting

### Zonal Lumen Summary

Zone	Lumens	%Fixt
0-20°	9,998	17.0%
0-30°	21,317	36.3%
0-40°	34,727	59.1%
20-50°	35,995	61.3%
40-70°	21,199	36.1%
0-60°	52,364	89.2%
0-80°	58,000	98.8%
0-90°	58,644	99.9%
90-180°	71	0.1%
0-180°	58,715	100.0%

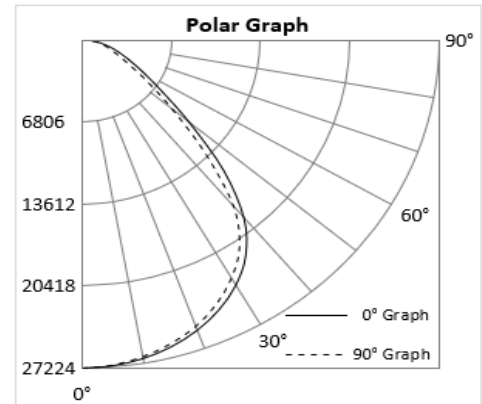

## CORDS & PLUGS

When ordering a plug, use the following suffix choices.

Example: 20-FHBSR-181512L-4K5K-P515

Note: plugs do not affect the ability to install sensors.

Part number suffix	Description	For use with
6C3	6' cord - 3 conductor (black/white/green)	Standard & UNC
6C4	6' cord - 4 conductor (black/white/green/red)	EM driver
6C5	6' cord - 5 conductor (black/white/green/purple/pink)	Dimming (standard & UNC)
6C6	6' cord - 6 conductor (black/white/green/red/purple/pink)	Dimming & EM driver
10C3	10' cord - 3 conductor (black/white/green)	Standard & UNC
10C4	10' cord - 4 conductor (black/white/green/red)	EM driver
10C5	10' cord - 5 conductor (black/white/green/purple/pink)	Dimming (standard & UNC)
10C6	10' cord - 6 conductor (black/white/green/red/purple/pink)	Dimming & EM driver
15C3	15' cord - 3 conductor (black/white/green)	Standard & UNC
15C4	15' cord - 4 conductor (black/white/green/red)	EM driver
15C5	15' cord - 5 conductor (black/white/green/purple/pink)	Dimming (standard & UNC)
15C6	15' cord - 6 conductor (black/white/green/red/purple/pink)	Dimming & EM driver
6W3	6' whip - 3 conductor (black/white/green)	Standard & UNC
6W4	6' whip - 4 conductor (black/white/green/red)	EM driver
6W5	6' whip - 5 conductor (black/white/green/purple/pink)	Dimming (standard & UNC)
6W6	6' whip - 6 conductor (black/white/green/red/purple/pink)	Dimming & EM driver
6P515	6' cord - 3 conductor (black/white/green) - NEMA 5-15 plug (120V/15A)	Standard luminaire
6P615	6' cord - 3 conductor (black/white/green) - NEMA 6-15 plug (240V/15A)	Standard luminaire
6P715	6' cord - 3 conductor (black/white/green) - NEMA 7-15 plug (277V/15A)	Standard luminaire
6P520	6' cord - 3 conductor (black/white/green) - NEMA 5-20 plug (120V/20A)	Standard luminaire
6P620	6' cord - 3 conductor (black/white/green) - NEMA 6-20 plug (277V/20A)	Standard luminaire



PROJECT
TYPE
CATALOG #

# 20-FHBSR

SENSOR READY FULL-BODY HIGH BAY LUMEN & KELVIN SELECTABLE

Part number suffix	Description	For use with
6P515L	6' cord - 3 conductor (black/white/green) - NEMA L5-15 plug (120V/15A locking)	Standard luminaire
6P615L	6' cord - 3 conductor (black/white/green) - NEMA L6-15 plug (240V/15A locking)	Standard luminaire
6P715L	6' cord - 3 conductor (black/white/green) - NEMA L7-15 plug (277V/15A locking)	Standard luminaire
6P520L	6' cord - 3 conductor (black/white/green) - NEMA L5-20 plug (120V/20A locking)	Standard luminaire
6P620L	6' cord - 3 conductor (black/white/green) - NEMA L6-20 plug (240V/20A locking)	Standard luminaire
6P720L	6' cord - 3 conductor (black/white/green) - NEMA L7-20 plug (277V/20A locking)	Standard luminaire
6P2420L	6' cord - 3 conductor (black/white/green) - NEMA L24-20 plug (347V/20A locking)	UNC luminaire
6P820L	6' cord - 3 conductor (black/white/green) - NEMA L8-20 plug (480V/20A locking)	UNC luminaire
10P515	10' cord - 3 conductor (black/white/green) - NEMA 5-15 plug (120V/15A)	Standard luminaire
10P615	10' cord - 3 conductor (black/white/green) - NEMA 6-15 plug (240V/15A)	Standard luminaire
10P715	10' cord - 3 conductor (black/white/green) - NEMA 7-15 plug (277V/15A)	Standard luminaire
10P520	10' cord - 3 conductor (black/white/green) - NEMA 5-20 plug (120V/20A)	Standard luminaire
10P620	10' cord - 3 conductor (black/white/green) - NEMA 6-20 plug (277V/20A)	Standard luminaire
10P515L	10' cord - 3 conductor (black/white/green) - NEMA L5-15 plug (120V/15A locking)	Standard luminaire
10P615L	10' cord - 3 conductor (black/white/green) - NEMA L6-15 plug (240V/15A locking)	Standard luminaire
10P715L	10' cord - 3 conductor (black/white/green) - NEMA L7-15 plug (277V/15A locking)	Standard luminaire
10P520L	10' cord - 3 conductor (black/white/green) - NEMA L5-20 plug (120V/20A locking)	Standard luminaire
10P620L	10' cord - 3 conductor (black/white/green) - NEMA L6-20 plug (240V/20A locking)	Standard luminaire
10P720L	10' cord - 3 conductor (black/white/green) - NEMA L7-20 plug (277V/20A locking)	Standard luminaire
10P2420L	10' cord - 3 conductor (black/white/green) - NEMA L24-20 plug (347V/20A locking)	UNC luminaire
10P820L	10' cord - 3 conductor (black/white/green) - NEMA L8-20 plug (480V/20A locking)	UNC luminaire
15P515	15' cord - 3 conductor (black/white/green) - NEMA 5-15 plug (120V/15A)	Standard luminaire
15P615	15' cord - 3 conductor (black/white/green) - NEMA 6-15 plug (240V/15A)	Standard luminaire
15P715	15' cord - 3 conductor (black/white/green) - NEMA 7-15 plug (277V/15A)	Standard luminaire
15P520	15' cord - 3 conductor (black/white/green) - NEMA 5-20 plug (120V/20A)	Standard luminaire
15P620	15' cord - 3 conductor (black/white/green) - NEMA 6-20 plug (277V/20A)	Standard luminaire
15P515L	15' cord - 3 conductor (black/white/green) - NEMA L5-15 plug (120V/15A locking)	Standard luminaire
15P615L	15' cord - 3 conductor (black/white/green) - NEMA L6-15 plug (240V/15A locking)	Standard luminaire
15P715L	15' cord - 3 conductor (black/white/green) - NEMA L7-15 plug (277V/15A locking)	Standard luminaire
15P520L	15' cord - 3 conductor (black/white/green) - NEMA L5-20 plug (120V/20A locking)	Standard luminaire
15P620L	15' cord - 3 conductor (black/white/green) - NEMA L6-20 plug (240V/20A locking)	Standard luminaire
15P720L	15' cord - 3 conductor (black/white/green) - NEMA L7-20 plug (277V/20A locking)	Standard luminaire
15P2420L	15' cord - 3 conductor (black/white/green) - NEMA L24-20 plug (347V/20A locking)	UNC luminaire
15P820L	15' cord - 3 conductor (black/white/green) - NEMA L8-20 plug (480V/20A locking)	UNC luminaire

PROJECT
TYPE
CATALOG #

# 20-FHBSR

SENSOR READY FULL-BODY HIGH BAY LUMEN & KELVIN SELECTABLE

## DIMENSIONAL DRAWINGS

**20-FHBSR-181512L-4K5K**

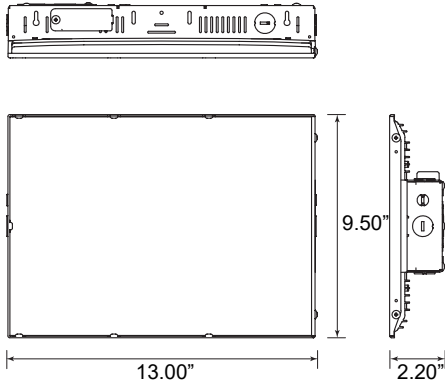

**20-FHBSR-241815L-4K5K**

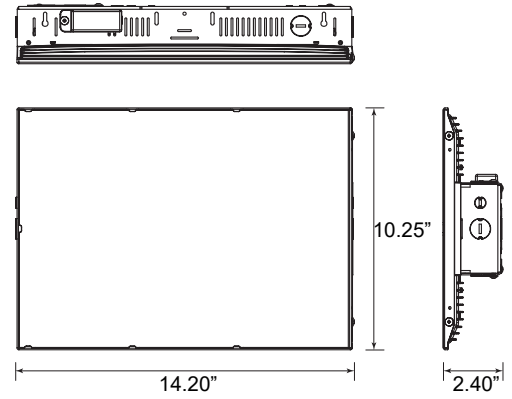

**20-FHBSR-363024L-4K5K**

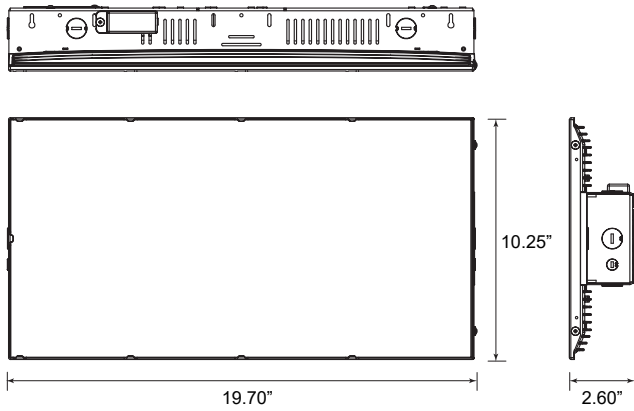

**20-FHBSR-604836L-4K5K**

